

HST[®]

HLOGIC SECURITY TECHNOLOGY

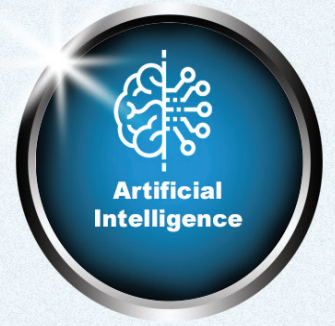

2024

Metal Detector 6 zone

www.hlogicgroup.com

HST270SA - 6 Series

Side Panel Digital Control Box



WATERPROOF



ACCESS CONTROL
CONNECTING



LED LIGHT
INDICATOR



MODULAR
DESIGN



PASSWORD
PROTECTION



VOLUME
ADJUSTABLE



HIGH
PRECISION



LED DISPLAY



SENSITIVITY
ADJUSTABLE

- 6 Zones for enhanced precision in threat detection;
- Perfect for space - constrained environments;
- Built to withstand daily use in high - traffic areas;
- User - friendly operation;
- 3 Years warranty;

Conform to Electricity EN60950 Safety Standard

Conform to Radiation EN50081 - 1 Standard

Conform to Anti - interference EN50082 - 1 Standard

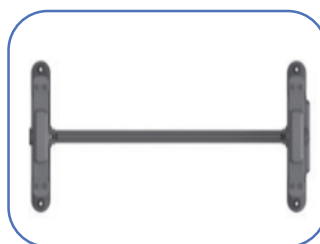
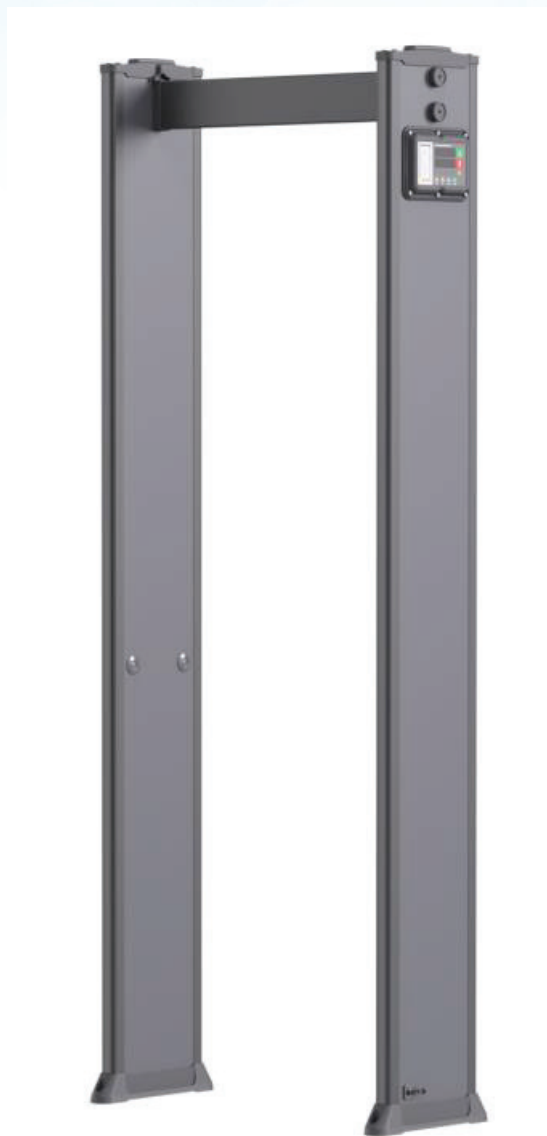

Product Specification

Overall Exterior Size	2165*828*349mm
Passageway Interior Size	2017*720*349mm
Operating Voltage	AC100V ~240V 50 / 60Hz
Power	12W
Operating Temperatures	-20 ~ 65
Installation Environment	Width 100cm* Length 200cm (minimum range without metal)

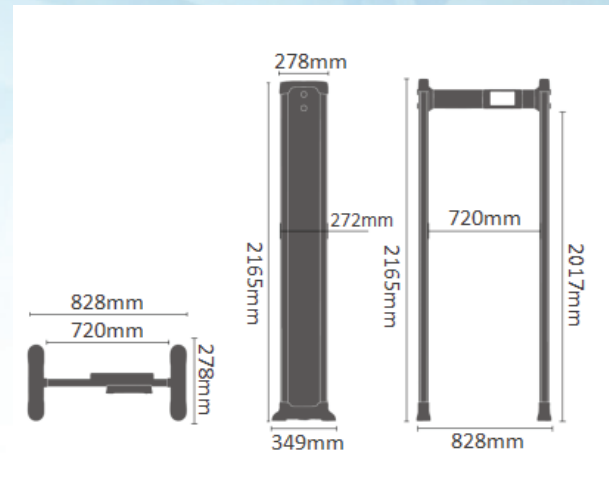

Function Configuration

Detection Zones	6 Vertical Zones
Pass Count	0-99999
Alarm Count	0-99999
Metal Detection Accuracy Range	One - dollar coin
User Interface	Dual sets of bright red and green digital tube display + integrated four - button panel operation mode
Password Protection Function	5 - digit password protection
Operating Frequency	0 - 99
Security Level	0 - 99
Sensitivity Level	0 - 400
Alarm Volume	0 - 99
Alarm Tone	1 - 99
Alarm Time	1 - 99
Scene Setting	72 preset scenes
Infrared Setting	0 - Both groups OFF 1 - Front group ON 2 - Rear group ON 3 - Both groups ON
Left and right LED Bars	Interchangeable
LED Alarm Bars	Front 2 groups
Simultaneous detection and alarm in multiple zones	2 Detection zones simultaneously alarm

Optional Functions: The above zones can be equipped with the following functions

- Secondary Development Port/Upgrade Port
- Front and Rear Panel Alarm LED Lights
- Turnstile Connection

Interface Display

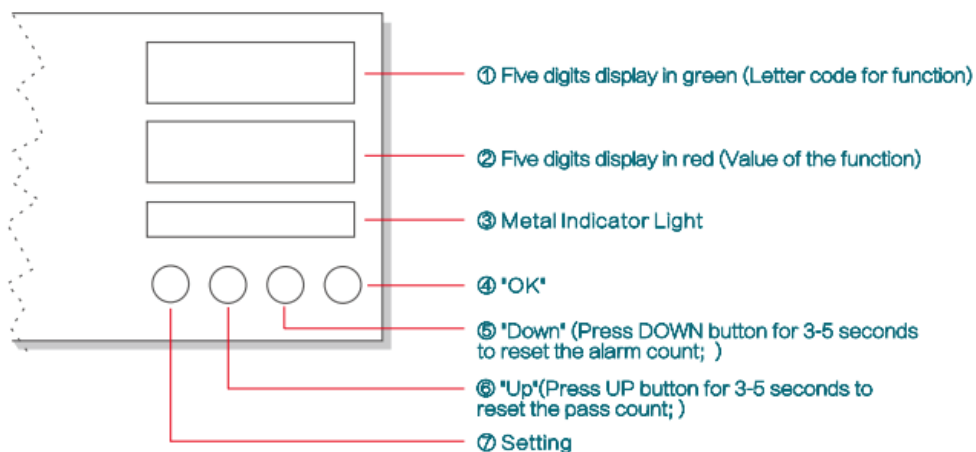

Anti - interference Reference Standard

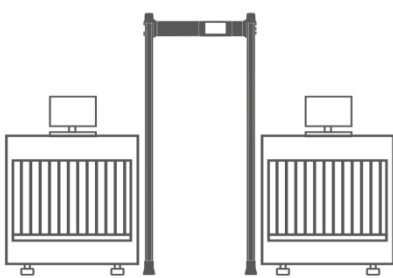

Keep $\geq 80\text{cm}$ from the X -Ray machine



Keep $\geq 50\text{cm}$ between two units

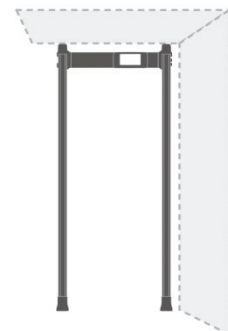

Keep $\geq 10\text{cm}$ from the wall

Note: The above distances are for reference only, and the actual distances shall be subject to the performance accuracy of on -site debugging; the higher the sensitivity, the greater the distance interval, and the lower the sensitivity, the smaller the distance interval.

Test kits

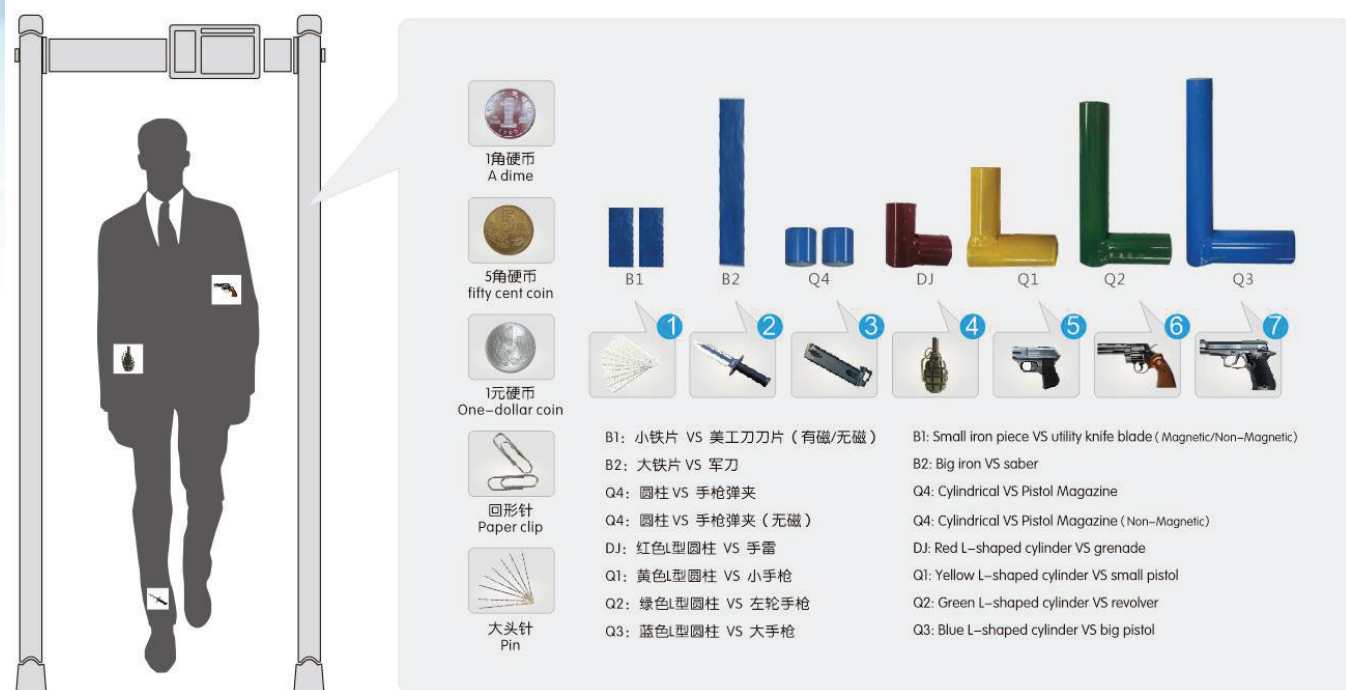

The diagram shows a person walking through a metal detector. A callout box lists various test kit items and their corresponding detector responses:

- 1角硬币 A dime
- 5角硬币 fifty cent coin
- 1元硬币 One-dollar coin
- 回形针 Paper clip
- 大头针 Pin
- B1: 小铁片 VS 美工刀刀片 (有磁/无磁)
- B2: 大铁片 VS 军刀
- Q4: 圆柱 VS 手枪弹夹 (无磁)
- DJ: 红色L型圆柱 VS 手雷
- Q1: 黄色L型圆柱 VS 小手枪
- Q2: 绿色L型圆柱 VS 左轮手枪
- Q3: 蓝色L型圆柱 VS 大手枪
- B1: Small iron piece VS utility knife blade (Magnetic/Non-Magnetic)
- B2: Big iron VS saber
- Q4: Cylindrical VS Pistol Magazine
- Q4: Cylindrical VS Pistol Magazine (Non-Magnetic)
- DJ: Red L-shaped cylinder VS grenade
- Q1: Yellow L-shaped cylinder VS small pistol
- Q2: Green L-shaped cylinder VS revolver
- Q3: Blue L-shaped cylinder VS big pistol

Detection Zone

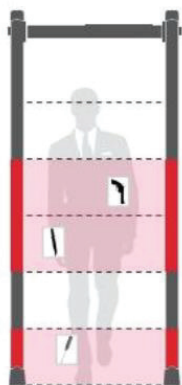

6 zones

Package

Packaging :	Carton box
Package Size :	L2245xW635 xH200mm
Volume :	0.29m ³
Net weight :	24kg
Gross weight :	30kg



The logo for HST, featuring the letters 'HST' in a bold, blue, sans-serif font. The 'H' and 'S' are connected, and the 'T' is slightly separated. A registered trademark symbol (®) is located to the upper right of the 'T'.

HST[®]

MORE THAN SECURITY



www.hlogicgroup.com 🔍